

# 0.5mm Pitch Low-Profile Board-to-Board/Board-to-FPC Connectors

## DF23 Series

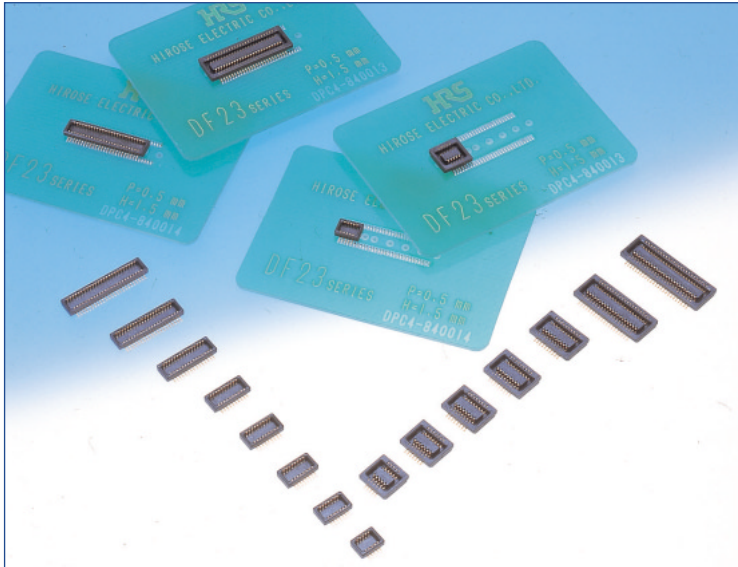

### Low profile - 1.5 mm board-to-board distance

#### ● Board-to-Board Application

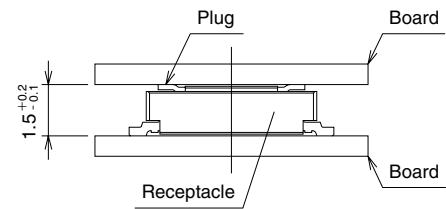

#### ● Board-to-FPC Application

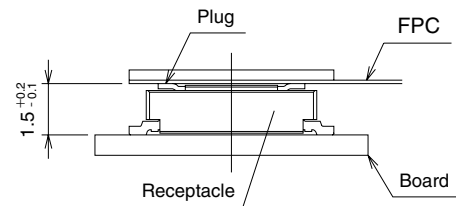

### ■ Features

#### 1. Low profile

The 1.5 mm board-to-board distance makes these connectors ideal for limited space applications.

#### 2. Large variety of number of contacts

Available with 10, 12, 14, 16, 18, 20, 30, 40, 50, and 60 contacts.

Connectors with 10 to 20 contacts are ideal for use in small LCD connections in cellular phones, PDA's, video equipment, photo cameras and miniature of other devices requiring reliable connections in a small spaces.

#### 3. Click sensation

Positive click sensation when completely mated confirms correct insertion and connection of all contacts.

#### 4. High contact reliability

Although connectors are low profile, the female contacts maintain reliable spring force assuring secure electrical contact.

#### 5. Large self-alignment

The large range of alignment of 0.3 mm allows for smooth insertion.

#### 6. Board placement with automatic equipment

Flat surfaces allows placement of embossed tape packaged connectors with vacuum nozzles.

### ■ Applications

Mobile phones, PDA's, notebook PC's, digital cameras and other miniature devices.

### High Contact Reliability

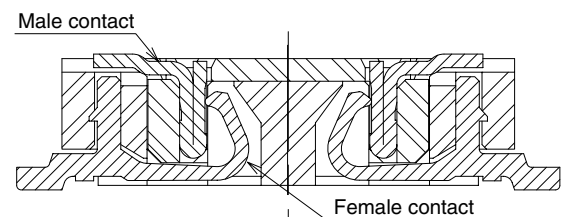

### Large Self-alignment

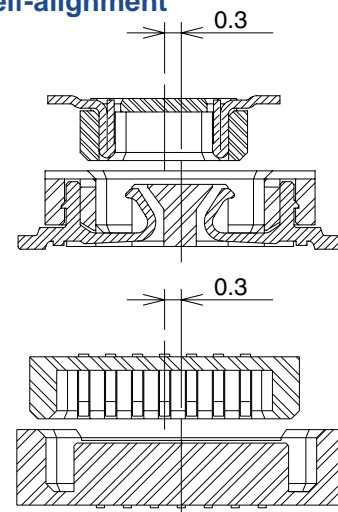

## Product Specifications

Ratings	Current rating	0.3A	Operating temperature range	-35°C to 85°C (Note 1)	Storage temperature range	-10°C to 60°C (Note 2)
	Voltage rating	50V AC	Operating humidity range	20% to 80%	Storage humidity range	40% to 70% (Note 2)

Item	Specification	Condition
1. Insulation resistance	500M ohms min.	100V DC
2. Withstanding voltage	No flashover or insulation breakdown	150V AC/1 minute
3. Contact resistance	60m ohms max.	100mA
4. Vibration	No momentary disconnections of 1 μs min	Frequency of 10 to 55 Hz, single amplitude of 0.75 mm, in 3 directions for 2 hours
5. Humidity	Contact resistance : 60 m ohms max. Insulation resistance : 250 M ohms min.	Temperature of 40°C±2°C, humidity of 90% to 95%, 96 hours
6. Temperature cycle	Contact resistance : 60 m ohms max. Insulation resistance : 500 M ohms min.	(-55°C : 30minutes →5 to 35°C : 10minutes →85°C : 30minutes →5 to 35°C: 10minutes ) for 5 cycles
7. Durability	Contact resistance : 60m ohms max.	50 cycles (mating/unmating)
8. Resistance to soldering heat	No deformation of the insulator parts affecting performance	Reflow: At recommended temperature profile Manual soldering: Soldering iron temperature 300°C, for 3 seconds

Note 1: Includes temperature rise caused by the current flow.

Note 2: The term "storage" refers to products stored for long period of time prior to mounting and use. Operating Temperature Range and Humidity range covers non- conducting condition of installed connectors in storage, shipment or during transportation.

## Materials

Item	Part	Material	Finish	Remarks
Receptacles Plugs	Insulator	LCP	Color : Black	UL94V-0
	Contacts	Phosphor bronze	Gold plated	—

## Ordering information

### Receptacles/Plugs

**DF23** **C** - **\*** **DS** - **0.5** **V** ( **\*\*** )  

1
2
3
4
5
6
7

<b>1</b> Series name: DF23	<b>5</b> Contact pitch: 0.5mm
<b>2</b> Metal fitting & Locating boss type C: Without metal fittings, without Locating boss	<b>6</b> Terminal type V: Straight SMT
<b>3</b> Number of contacts: 10, 12, 14, 16, 18, 20, 30, 40, 50, 60	<b>7</b> Packaging type Receptacle(51): Embossed tape packaging (2,000 pieces per reel) Receptacle(53): Embossed tape packaging (3,000 pieces per reel) Plug(92): Embossed tape packaging (2,000 pieces per reel) Plug(91): Embossed tape packaging (3,000 pieces per reel)
<b>4</b> Connector type DS: Double-row receptacle DP: Double-row plug	

## ■ Receptacles

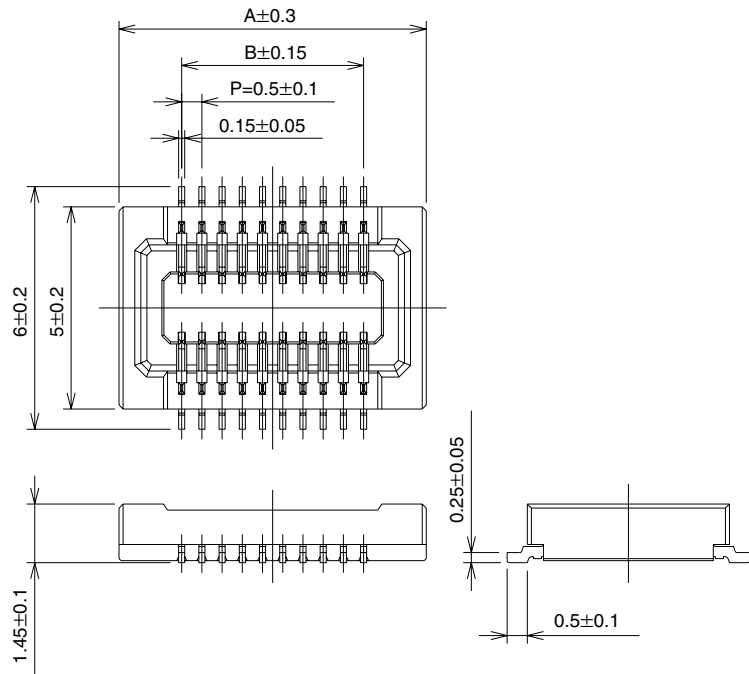
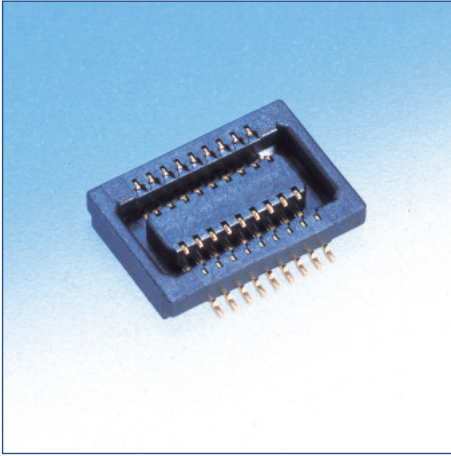

## ◆ Recommended PCB Footprints

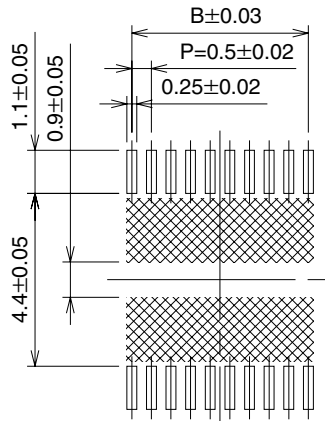

Note: Shaded area should be free of any conductive traces.

[Packaging/ quantity per reel code] - \*\*, (\* \*)  
 (51): Embossed tape packaging (2,000 pieces per reel)  
 (53): Embossed tape packaging (3,000 pieces per reel)

Unit: mm

Product No.	CL No.	Number of Contacts	A	B	Remarks
DF23C-10DS-0.5V (**)	CL688-0306-9- **	10	5.1	2.0	
DF23C-12DS-0.5V (**)	CL688-0309-7- **	12	5.6	2.5	(Note 2)
DF23C-14DS-0.5V (**)	CL688-0300-2- **	14	6.1	3.0	(Note 1)
DF23C-16DS-0.5V (**)	CL688-0307-1- **	16	6.6	3.5	(Note 1)
DF23C-18DS-0.5V (**)	CL688-0308-4- **	18	7.1	4.0	(Note 2)
DF23C-20DS-0.5V (**)	CL688-0301-5- **	20	7.6	4.5	(Note 1)
DF23C-30DS-0.5V (**)	CL688-0302-8- **	30	10.1	7.0	(Note 1)
DF23C-40DS-0.5V (**)	CL688-0303-0- **	40	12.6	9.5	(Note 1)
DF23C-50DS-0.5V (**)	CL688-0304-3- **	50	15.1	12.0	(Note 1)
DF23C-60DS-0.5V (**)	CL688-0305-6- **	60	17.6	14.5	(Note 1)

Note 1: Available in code (51) only.

Note 2: Available in code (53) only.

Note 3: Contact Hirose for availability.

Note 4: Please order embossed tape packaging items by the reel.

## Plugs

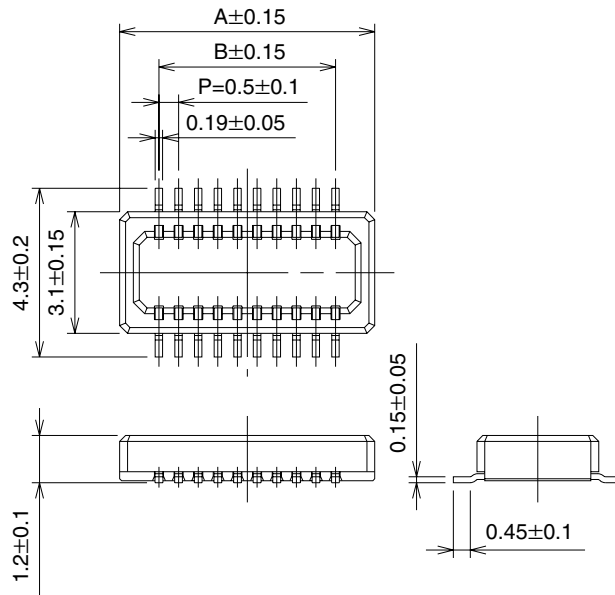
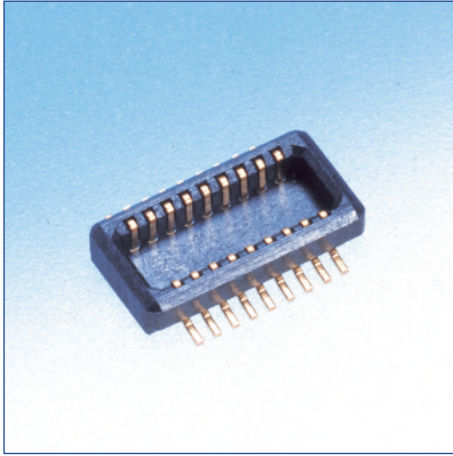

## Recommended PCB Footprints

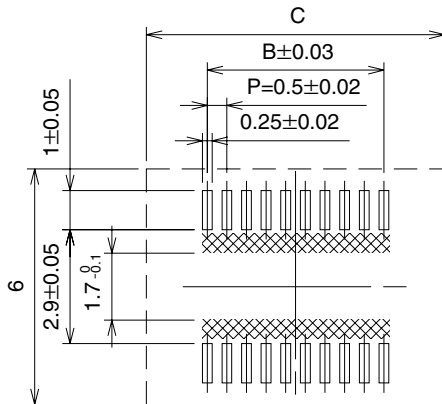

Note 1: Shaded area should be free of any conductive traces.

Note 2: Do not leave any conductive traces or install components in this area.

[Packaging/ quantity per reel code] - \*\*, (\*\*)  
 (92): Embossed tape packaging (2,000 pieces per reel)  
 (91): Embossed tape packaging (3,000 pieces per reel)

Unit: mm

Product No.	CL No.	Number of Contacts	A	B	C	Remarks
DF23C-10DP-0.5V (**)	CL688-0806-1- **	10	4.0	2.0	5.1	(Note 1)
DF23C-12DP-0.5V (**)	CL688-0809-0- **	12	4.5	2.5	5.6	(Note 1)
DF23C-14DP-0.5V (**)	CL688-0800-5- **	14	5.0	3.0	6.1	(Note 2)
DF23C-16DP-0.5V (**)	CL688-0807-4- **	16	5.5	3.5	6.6	(Note 2)
DF23C-18DP-0.5V (**)	CL688-0808-7- **	18	6.0	4.0	7.1	
DF23C-20DP-0.5V (**)	CL688-0801-8- **	20	6.5	4.5	7.6	
DF23C-30DP-0.5V (**)	CL688-0802-0- **	30	9.0	7.0	10.1	(Note 2)
DF23C-40DP-0.5V (**)	CL688-0803-3- **	40	11.5	9.5	12.6	(Note 2)
DF23C-50DP-0.5V (**)	CL688-0804-6- **	50	14.0	12.0	15.1	(Note 2)
DF23C-60DP-0.5V (**)	CL688-0805-9- **	60	16.5	14.5	17.6	(Note 2)

Note 1: Available in code (91) only.

Note 2: Available in code (92) only.

Note 3: Contact Hirose for availability.

Note 4: Please order embossed tape packaged items by the reel.

## ◆ Embossed Career Tape Dimensions

### ■ Receptacles

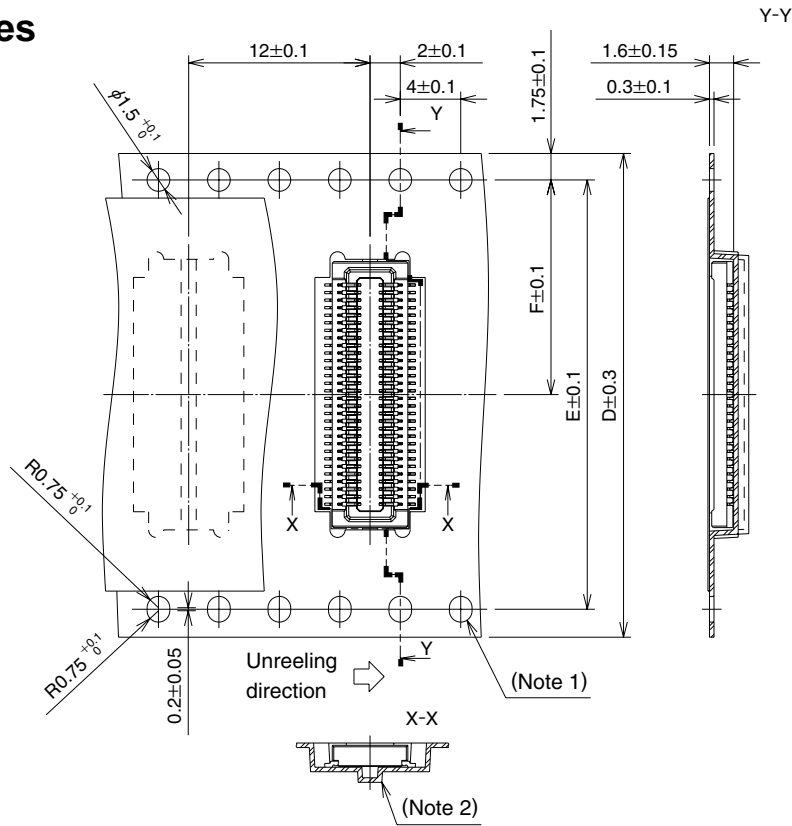

### ■ Reel Dimensions

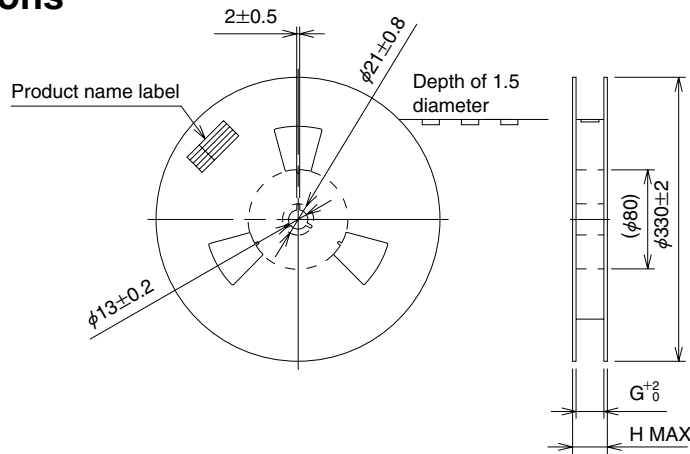

Unit: mm

Product No.	D	E	F	G	H
DF23C-10DS-0.5V (**)	16.0	—	7.5	16.4	22.4
DF23C-12DS-0.5V (**)	16.0	—	7.5	16.4	22.4
DF23C-14DS-0.5V (**)	16.0	—	7.5	16.4	22.4
DF23C-16DS-0.5V (**)	16.0	—	7.5	16.4	22.4
DF23C-18DS-0.5V (**)	16.0	—	7.5	16.4	22.4
DF23C-20DS-0.5V (**)	16.0	—	7.5	16.4	22.4
DF23C-30DS-0.5V (**)	24.0	—	11.5	24.4	30.4
DF23C-40DS-0.5V (**)	24.0	—	11.5	24.4	30.4
DF23C-50DS-0.5V (**)	24.0	—	11.5	24.4	30.4
DF23C-60DS-0.5V (**)	32.0	28.4	14.2	32.4	38.4

Note 1: This side feed hole is added to embossed tape where the D dimension is 32.0 min. wide.

Note 2: (53) packaging code embossed tape is without the bottom surface protrusion.

## ■Plugs

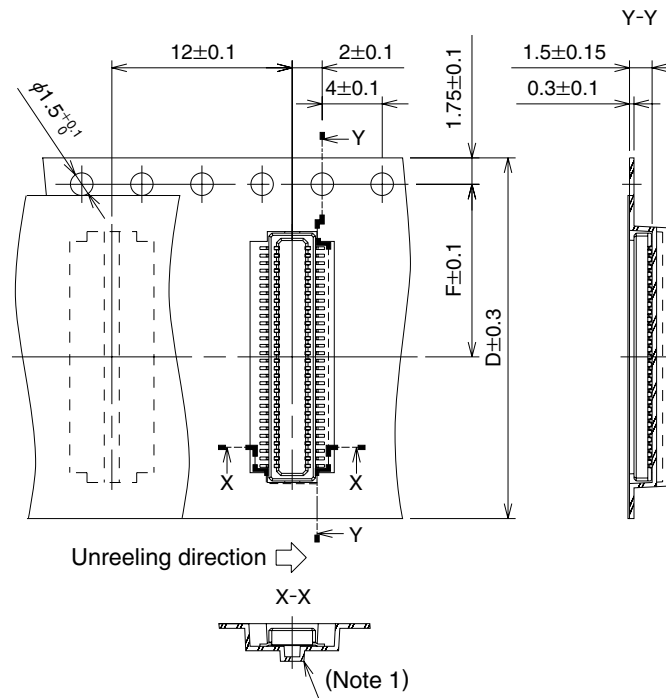

## ■Reel Dimensions

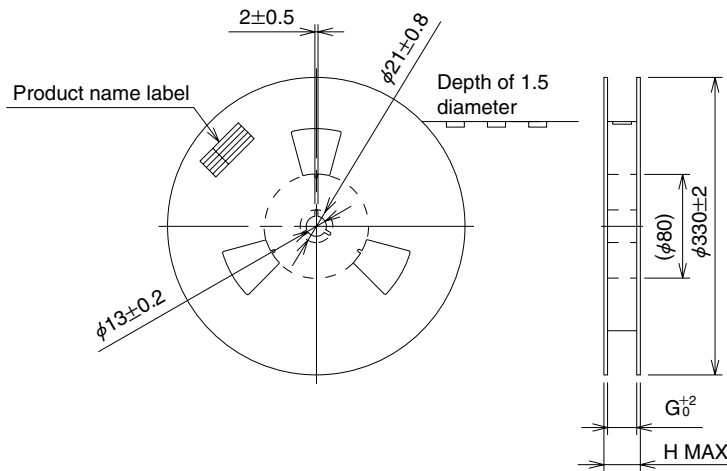

Unit: mm

Product No.	D	F	G	H
DF23C-10DP-0.5V ( ** )	16.0	7.5	16.4	22.4
DF23C-12DP-0.5V ( ** )	16.0	7.5	16.4	22.4
DF23C-14DP-0.5V ( ** )	16.0	7.5	16.4	22.4
DF23C-16DP-0.5V ( ** )	16.0	7.5	16.4	22.4
DF23C-18DP-0.5V ( ** )	16.0	7.5	16.4	22.4
DF23C-20DP-0.5V ( ** )	16.0	7.5	16.4	22.4
DF23C-30DP-0.5V ( ** )	16.0	7.5	16.4	22.4
DF23C-40DP-0.5V ( ** )	24.0	11.5	24.4	30.4
DF23C-50DP-0.5V ( ** )	24.0	11.5	24.4	30.4
DF23C-60DP-0.5V ( ** )	24.0	11.5	24.4	30.4

Note : Code number (91) embossed tape is without the bottom surface protrusion.

## ◆ Usage Precautions

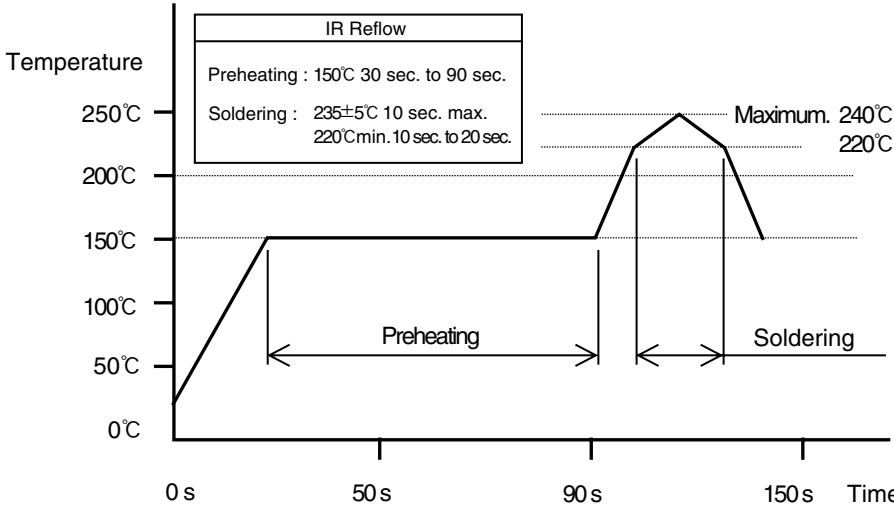
<p>1.Recommended Temperature Profile Temperature</p>	 <p>The graph shows a temperature profile for IR reflow. The y-axis is Temperature (0°C to 250°C) and the x-axis is Time (0s to 150s). The profile starts at 0°C, rises to 150°C by 30s, and remains constant until 90s (Preheating). It then rises to a peak of 240°C, stays there for 10s, and then falls back to 150°C by 150s (Soldering). A box labeled 'IR Reflow' contains the following details: Preheating: 150°C 30 sec. to 90 sec.; Soldering: 235±5°C 10 sec. max., 220°C min. 10 sec. to 20 sec. The peak temperature is labeled 'Maximum. 240°C' and the temperature during the peak is labeled '220°C'.</p> <p>Note 1: Up to 2 cycles are possible under the same conditions provided that there is a return to normal temperature between the first and second cycle.</p> <p>Note 2: This temperature profile indicates the temperature of the connector terminal lead at the point of contact with the PCB.</p>
<p>2.Recommended Manual Soldering Conditions</p>	<p>Temperature: 290°C±10°C, Soldering time: within 2 sec.</p>
<p>3.Recommended Screen Thickness and Open Area Ratio (Pattern Area Ratio)</p>	<p>Thickness : 0.12 mm Open Area ratio: 80%</p>
<p>4.Board Warping</p>	<p>Maximum of 0.03 mm at the connector center section, with both ends of the connector as reference points.</p>
<p>5.Cleaning Conditions</p>	<p>Refer to the "Nylon Connector Use Handbook."</p>
<p>6.Use and handling precautions.</p>	<p>■When manually handling the connectors avoid touching any portion of exposed terminal leads. This may cause deformation and lead to difficulties with placement and soldering on the PCB.</p> <p>When mating/un-mating do not use excessive force or lifting of one side only.</p>